



**MATERIALES**<sup>®</sup>  
INDUSTRIALES

**CATÁLOGO  
INDUSTRIAL | 2023**

# NUESTRAS LÍNEAS



# HISTORIA

Pensando en las necesidades del mercado ferretero-industrial de nuestro país, en el año 1985 inicia su actividad comercial con una ferretería. Desde entonces, su principal objetivo ha sido la venta y distribución de artículos ferreteros, tanto al por mayor como al detalle, cubriendo todo el territorio nacional.

## 1986

- MARZO - Las ventas al por mayor iniciaron sus operaciones.
- JUNIO - Con la finalidad de establecer lazos directos con el consumidor final, la empresa abre las puertas de su tienda. Localizada en la Av. Máximo Gómez #100, esq. Tunti Cáceres.

## 1997

- Por razones de expansión la empresa decide trasladar su oficina principal al igual que sus operaciones comerciales a la Av. San Martín #183, casi esq. Máximo Gómez.

Desde entonces hasta la fecha su principal preocupación ha sido mantener una oferta innovadora, caracterizada por la constante introducción de nuevos productos que permitan satisfacer las demandas actuales del mercado.

Materiales Industriales cuenta con un equipo de trabajo destinado a ofrecer un servicio personalizado a sus clientes en los distintos departamentos. Entre ellos: Electricidad, Herrajes, Herramientas, Maquinarias, Plomería, entre otros.



**TALADRO MARTILLO 1/2" M12 FUEL  
+ LLAVE DE IMPACTO 1/4" M12 FUEL**  
2 baterías, cargador y maletín #2598-22  
(062278)



**TALADRO MARTILLO 3/8" M12  
+ LLAVE DE IMPACTO 1/4" M12**  
2 baterías, cargador y maletín  
#2497-22  
(051173)



**BRILLADORA M12**  
2 baterías, cargador y Kit de 5 accesorios  
(1 Borla de lana, 1 esponja amarilla, 1 esponja blanca,  
1 respaldo para pulidora 3", 1 respaldo para lijadora 2")  
#2438-22  
(033961)



**TALADRO MARTILLO DE  
1/2" M12 FUEL** 2 baterías,  
cargador y maletín  
#2504-22  
(060978)



**REMACHADORA M12**  
2 baterías, cargador y maletín  
#2550-22  
(065006)



**DESTORNILLADOR  
COMPACTO DE 1/4" M12**  
2 baterías, cargador y maletín  
#2401-22  
(026795)



**TALADRO ROTOMARTILLO  
DE 3/8" M12** 2 baterías,  
cargador y maletín #2408-22  
(054623)



**CORTADORA TUBOS DE  
COBRE M12** 1 batería,  
cargador y maletín #2471-21  
(069500)



**CHICHARRA M12 FUEL**  
061847 3/8" #2557-22  
061846 1/2" #2558-22



**SIERRA BANDA**  
1 batería, cargador y maletín  
#2429-21XC  
(067079)



**SIERRA SABLE HACKZALL M12**  
1 batería, cargador y maletín  
#2420-21  
(036308)



**GRAPADORA DE 3/8" M12**  
1/4"-9/16" 1 batería,  
cargador y maletín #2447-21  
(072073)







**M18**



**TALADRO MARTILLO DE 1/2" M18 + DESTORNILLADOR DE 1/4" M18** 2 baterías, cargador y estuche #2697-22CT (054624)



**TALADRO MARTILLO DE 1/2" M18** 2 baterías, cargador y estuche #2607-22CT (051172)



**TALADRO DE 1/2" M18** 2 baterías, cargador y estuche #2802-22CT (068207)



**TALADRO DE 1/2" FUEL M18** 2 baterías, cargador y estuche  
052711 Rotomartillo #2804-22  
054060 Destornillador #2803-22



**LLAVE DE IMPACTO DE ALTO TORQUE DE 3/4" M18** 2 baterías, cargador y estuche #2864-22 (064174)



**LLAVE DE IMPACTO DE ALTO TORQUE DE 1/2" M18** 2 baterías, cargador y estuche #2767-22 (060979)



**LLAVE DE IMPACTO TORQUE MEDIO DE 1/2" M18** 2 baterías, cargador y estuche #2860-22CT (062279)



**LLAVE DE IMPACTO DE ALTO TORQUE DE 1" M18** 2 baterías, cargador y estuche #2867-22 (069416)



**DESTORNILLADOR DE IMPACTO DE 1/4" M18** 2 baterías, cargador y estuche #2853-22 (056821)



**KNOCKOUT DE 1/2" - 4" M18** 1 batería, cargador y estuche #2676-20 (051179)



**CORTADORA BARRAS ROSCADAS M18** 1 batería, cargador y estuche #2872-21CT (068205)



**BLOWER COMPACTO M18** 1 batería, cargador y estuche #2688-21 (060981)





**TALADRO ROTOMARTILLO DE 1-1/8" SDS PLUS M18**  
2 baterías, cargador, mango auxiliar y estuche #2715-22 (052706)



**TALADRO ROTOMARTILLO DE 1-9/16" SDS MAX M18**  
2 baterías, cargador y estuche #2717-22 (056824)



**TALADRO ROTOMARTILLO DE 1" SDS PLUS M18**  
2 baterías y cargador #2713-22 (063072)



**TALADRO ROTOMARTILLO SDS PLUS DE 7/8" M18**  
2 baterías, cargador, mango auxiliar, varilla de profundidad y estuche #2605-22 (011727)



**PULIDORA DE 7"-9" FUEL M18**  
1 batería, cargador y mango lateral #2785-21HD (064291)



**RECTIFICADOR DE 1/4" M18**  
2 baterías, cargador y maletín #2784-22 (058249)



**DESTUPIDOR DE TUBERÍAS M18**  
2 baterías, cargador y cubo de almacenamiento #2772-21 (060982)



**GRAPADORA FUEL M18**  
1 batería, cargador y bulto #2749-21CT (075783)



**MULTITOOL M18** 2 baterías, cargador y bulto #2626-22 (036306)



**ROSCADORA DE TUBOS DE 2" M18**  
2 baterías, cargador, brazo de soporte y estuche #2874-22HD (069417)



**CORTADOR CABLES 600 MCM M18**  
2 baterías, cargador y estuche #2679-22 (064668)



**RADIO RECARGABLE M18**  
cable auxiliar de 40 cm #2792-20 (054840)



**LÁMPARA LED M18**  
con tripode #2131-20 (068245)





**SIERRA DE CADENA 16" M18**

1 batería y Barra, cadena de Oregon 16" y cargador #2727-21HD (064290)

**TRIMMER DE SIERRA M18**

1 batería y cargador #2726-21HD (059778)

**SOPLADOR FUEL M18**

1 batería y cargador #2724-21HD (061844)

**TRIMMER DE CUERDA M18**

1 batería y cargador #2725-21HD (059777)



**SIERRA CALADORA M18** 1 batería, protector contra astillas, hoja para sierra, cargador y estuche ##2737-21 (067078)

**SIERRA DE MESA DE 8.1/4" M18**

1 batería, cargador, paletas antipatinaje, cuchilla, protector, calibre de inglete y cuchillo de rescate #2786-22HD (064292)

**CORTADORA DE MANO PARA CONCRETO 9" M18**

2 baterías, cargador, disco, disco para metal y estuche #2736-21HD (072074)

**SIERRA DE 12" M18**

1 batería y cargador #2739-21HD (072077)



**TALADRO ROTOMARTILLO SDS**  
1.1/8" 8 Amp 0 - 1,500 RPM  
#5268-21  
(038825)



**TALADRO ROTOMARTILLO SDS**  
1.1/32" 6.4 Amp 0 - 1,500 RPM  
#5386-21  
(028710)



**TALADRO ROTOMARTILLO SDS**  
7/8" 6.4 Amp 0 - 1,290 RPM  
#5485-21  
(006331)



**TALADRO ROTOMARTILLO SDS  
MAX** 1.9/16" 10.5 Amp 0 - 450 RPM  
#5317-21  
(052709)



**TALADRO ROTOMARTILLO SDS  
MAX** 1.3/4" 14 Amp 350 - 450 RPM  
#5546-21  
(025096)



**TALADRO ROTOMARTILLO 1"**  
8 Amp 0 - 1,500 RPM #5262-21  
(011726)



**TALADRO ROTOMARTILLO**  
1/2" 8.5 Amp Dual torque  
#5387-20  
(000464)



**DESTORNILLADOR**  
6.5 Amp 0 - 2,500 RPM  
#6791-21  
(089917)



**BLOWER DE CALENTAMIENTO**  
11.6 Amp 120 V  
001896 #8977-20  
033313 #8975-6



**TALADRO ROTOMARTILLO  
de 1/2"**  
006334 7.5 Amp #5375-20  
052710 5.6 Amp #5374-20



**TALADRO REVERSIBLE**  
1/2" 5.5 Amp #0234-6  
(021531)



**TALADRO REVERSIBLE 3/8"**  
006333 5.5 Amp #0233-20  
090585 7 Amp #0200-20



**TALADRO ROTOMARTILLO  
de 1/2" 7 Amp**  
021532 650 RPM #1610-1  
090584 450 RPM #1660-6



**DIFERENCIAL  
ELÉCTRICO 20'**  
088397 1 ton #9568  
088398 2 ton #9573





**SIERRA TRONZADORA 14"**  
15 Amp 3,900 RPM #6177-20  
(021558)



**SIERRA MITER SAW 12"**  
15 Amp 3,200 RPM #6955-20  
(023363)



**SIERRA DE BANDA 1"**  
6.5 Amp 0 - 3,000 SPM  
#6238-20  
(091585)



**SIERRA CALADORA 1"**  
6.2 Amp 500 - 3,000 RPM  
#6276-21  
(017863)



**SIERRA CIRCULAR 15 Amp**

082730 10.1/4" 5,200 RPM  
#6470-21

017362 7.1/4" 5,800 RPM  
#6430-20

009984 7.1/4" 5,800 RPM  
#6390-20



**SÚPER SIERRA SAWZALL**

021560 1.1/4" 13 Amp  
0-3,000 SPM #6536-21

038897 1.1/8" 12 Amp  
3,000 SPM #6519-30



**SIERRA PARA METAL 8"**

15 Amp 3,700 RPM  
#6370-21  
(098212)



**SIERRA PARA METAL 4"**

11 Amp 300 -380 RPM  
#6268-21  
(099931)







**TALADRO BASE  
ELECTROMAGNÉTICA**  
1.5/8" 13 Amp 475 RPM  
#4272-21  
(052081)



**BRILLADORA 7/9"**  
11 Amp 0 - 1,750 RPM #5460-6  
(099928)



**PULIDORA 4.1/2"**  
006142 7 Amp 11,000 RPM  
#6130-33  
024483 7.5 Amp 10,000 RPM  
#6140-30  
058029 11 Amp 11,000 RPM  
#6141-31



**PULIDORA 7" 15 Amp**  
038826 8,500 RPM #6086-30  
099929 6,000 RPM #6088-30



**PULIDORA 9"**  
15 Amp 6,000 RPM #6660-6  
(085317)



**CIZALLA CORTADORA**  
021933 Calibre 14 5 Amp #6815  
099930 Calibre 18 6.8 Amp #6852-20



**RECTIFICADOR 4.5 Amp**  
21,000 RPM #5194-1  
(021561)



**ESMERILADORA 6"**  
15 Amp 5,500 RPM #5243-1  
(021543)



**LIJADORA ORBITAL 3 Amp**  
051171 5" #6034-21  
052708 1/4" #6033-21



**ROUTER**  
093463 1.3/4 HP 11 Amp  
24,000 RPM #5615-21  
095664 2.1/4 HP 13 Amp  
10,000 - 24,000 RPM #5616-21



**ROUTER 3.1/2 HP 15 Amp**  
10,000 - 22,000 RPM #5616-21  
(097136)



SIERRAS COPA

PINZAS



CINTAS MÉTRICAS



DESTORNILLADORES



BATERÍAS

AMPLIA VARIEDAD EN

ACCESORIOS Y  
HERRAMIENTAS  
MANUALES



DETECTORES DE VOLTAJE



CINCELOS



AMPERÍMETROS



GUANTES



INFLADORES



ORGANIZADORES



MULTÍMETROS



TERMÓMETROS



BARRENAS DE DIAMANTE



BARRENAS



DISCOS



LINTERNAS



COLECTORES DE POLVO



SOLDADORES



CUCHILLAS





**LLAVE TORQUE**

055925	1" 200-1000 lbs/pie
055924	3/4" 150-750 lbs/pie
039194	3/8" 10-80 lbs/pulg



**LLAVE AJUSTABLE**

016889	10"
034532	12"
027496	24"

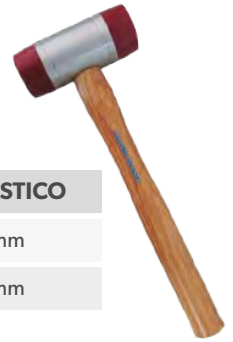

**MARTILLO PLASTICO**

018354	35mm
018355	45mm



**JUEGO LLAVE ALLEN**  
9 pcs 1.5-10mm  
(031571)



**ALICATE COMBINADO**  
9"  
(055048)



**PISTOLA DE IMPACTO NEUMATICA**

034531	1" de 1500 pies/lbs
034553	1/2" de 500 pies/lbs
034554	3/4" de 800 pies/lbs



**ARMARIO P/HERRAMIENTAS**

051666	Vacio
023154	Incluye Herramientas



**ALICATE FLEXIBLE**  
para abrazaderas  
(055057)



**CAJA DE HERRAMIENTAS**  
3 Sec. 470 X 220 X 345 mm  
(018359)



**JUEGO DESTORNILLADOR**  
Estria / Plano 7/1"  
(050988)





**MANGO ATRICULADO**  
3/4" X 18"  
(055050)

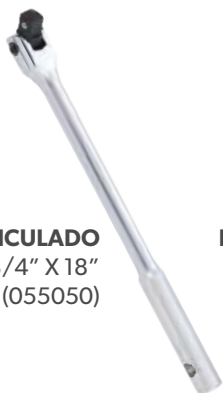

**PALOTE CORREDIZO**  
3/4" X 20"  
(018194)



**CHICHARRA REV.**  
1/2" X 10"  
(018154)



**ALICATE PRESION CURVO**  
10"  
(016890)



**JUEGO EXTRACTOR** con mango del tirador del engranaje  
(061471)

**JUEGO DE LLAVES COMBINADA**  
26/1 de 6-32mm  
(023161)



**COMPRESOR VÁLVULAS**  
10 pcs  
(058270)

**JUEGO DE CUBOS**  
16 Pcs conex.  
1/4" 4-13mm  
(011281)



**JUEGO DE CUBOS**  
16 Pcs conex.  
3/4" dobe hex  
(018190)





**SOPORTE PARA MOTORES**  
(099382)



**GATO PARA TRANSMISIÓN**  
(099384)



**TRÍPODE DE DOBLE SEGURIDAD**

- 087550 2 t
- 087551 3 t
- 087552 6 t



**GATO HIDRÁULICO TIPO RANA HEAVY DUTY**

- 087577 3 t      087545 5 t
- 087543 3.25 t      087546 10 t
- 087575 4 t



**GATO HIDRÁULICO TIPO RANA**

- 087544 2 t
- 087539 3 t



**GATO TIPO TIJERA**

- 087548 1.5 t
- 087549 2 t



**CUÑAS PARA RUEDAS**  
(099380)



**GATO HIDRÁULICO BOTELLA**

- 087515 2 t      087528 12 t
- 087516 4 t      087529 16 t
- 087519 6 t      087530 20 t
- 087521 8 t      087531 30 t
- 087522 10 t      087532 50 t



**BOTELLA HIDRÁULICA PARA GRÚA**  
(099383)



**CARRETE CON MANGUERA**  
3/8" X 50'  
PARA AIRE  
(046893)



**RAMPA PARA VEHÍCULOS**  
2.5 t  
(087568)



**GATO NEUMÁTICO BOTELLA**  
20 t  
(099386)



**HERRAMIENTA PARA ARREGLAR FRENOS**  
(087574)





**DREMEL NEUMÁTICO**  
con accesorios 10pcs  
(099392)



**JUEGO DE MANIFOLD**  
(099389)



**EQUIPO DESABOLLADOR  
HIDRÁULICO**

- 087547 4 t
- 087576 10 t



**CARRETILLA HIDRÁULICA**  
27" x 48" 3000 kg  
(099391)



**APILADOR HIDRÁULICA**  
Manual 2,000 Kg  
(087566)



**CAMILLA PARA MECÁNICOS**  
(099385)



**ASIENTO NEUMÁTICO**  
Para mecánicos  
(087567)



**GRÚA PLEGABLE**  
087553 1 t  
087554 2 t



**BALANCEADOR  
DE NEUMÁTICOS**  
24" 110-220V/60HZ/1P  
(046888)



**DESMONTADOR DE GOMAS**  
Para aros de vehículos  
13 pulg - 38 pulg  
(087564)



**PRENSA HIDRÁULICA**  
087555 20 t  
087561 30 t  
087562 50 t



# STANLEY®



**LAPEADORES DE VÁLVULAS**  
(056205)



**LLAVE AJUSTABLE**  
Cromada 10"  
(021147)



**ALICATE CORTE DIAGONAL 7"**  
(095671)



**ALICATE COMBINADO**  
8" con forro  
(098842)



**SERRUCHO ECONÓMICO 26"**  
(010159)



**CIZALLA PARA CORTAR VARILLAS**  
18"  
(010159)



**JUEGO DE LLAVES COMBINADAS**  
8/1 5/16" - 3/4"  
(099784)



**JUEGO LLAVES ALLEN 10 Pcs**  
(013497)



**CAJA PARA HERRAMIENTAS RODANTE**  
(054363)



**CINTA MÉTRICA METAL**  
021108 5M/16' x 3/4"  
087370 8M/25' x 1"  
Power Lock



**ABOCINADOR**  
(023133)



**CAJA PARA HERRAMIENTAS**  
19"  
(029889)



**CAJA METÁLICA PARA HERRAMIENTAS**  
(021094)



**CUCHILLA  
RETRÁCTIL**  
(089160)



**ALICATE DE  
PRESIÓN  
RECTO 10"**  
(085502)



**MARTILLO  
CARPINTERO  
PULIDO 20 Oz**  
(021154)



**LLAVE TORQUE  
DE AGUJA**  
conex. 1/2  
0-150 Lbs  
(098836)



**CUBO BIT**  
Conex. 1/2" x 5/8"  
(054864)



**JUEGO DESTORNILLADOR  
6/1 Pro**  
(013496)



**ALICATE Y LLAVES AJUSTABLES  
4/1**  
(000781)



**COMPRESIMETRO  
DE MANGUERA 0-300 Psi**  
(057330)



**ESPATULA**  
023136 10"  
023137 12"

**HIDROLAVADOR  
DE ALTA PRESIÓN**

- 059622 1740 PSI 1600W
- 059623 1885 PSI 1800W
- 059624 2103 PSI 1900W



**JUEGO DESTORNILLADOR  
7/1 1000V**  
(008891)



**JUEGO DE CUBOS HEXAGONALES**  
083938 Conex. 1/2" 14/1 3/8"-1"  
026087 Conex. 1/2" 25/1 10-17mm





**ALICATE DE PRESION  
SARGENTO**  
Tipo C 18"  
(021311)

**JUEGO DADOS Y MACHOS**  
76/1  
(016967)



**MARCO SEGUETA**  
019861 Alta tensión  
019862 Media tensión

**SERRUCHO**  
024041 20"/500mm  
024042 22"/550mm



**SERRUCHO CALADOR**  
6" manual para yeso  
(024047)



**JUEGO LLAVES ALLEN**  
25/1  
(067083)

**PRENSA DE BANCO**  
019855 4"  
019856 5"  
016960 6"





**SARGENTO MARIPOSA**  
3"  
(019852)



**PRENSA DE RESORTE**  
3"  
(067082)



**PRENSA DE MANO  
CON GATILLO**  
(019850)



**ALICATE  
ELECTRICISTA**  
9.1/2"  
(016186)



**ALICATE CORTE**  
8"  
(016188)



**ALICATE ELECTRICISTA**  
8.1/2"  
(015897)



**TIJERA PARA  
HOJALATERO**  
(024046)



**ALICATE PRESION  
PUNTA AGUJA**  
Mango de goma  
con corte 9"  
(034308)



**ALICATE MECANICO**  
8"  
(016190)



**PUNTA DE  
DESTORNILLADOR  
ESTRIA**  
Set 25 Pcs (009219)



**PUNTA ESTRIA DE  
IMPACTO**  
#3  
(056747)



**AVELLANADOR**  
3/4"  
(090134)



**PUNTA ESTRIA**  
N.2" X 3.5"  
(062305)



**EXTRACTOR DE  
TORNILLOS**  
Ex-6  
(010389)





**DISCO DE PULIR CLASSIC**

- 058831 4.1/2 x 1/4"
- 058832 7 x 1/4"



**PIEDRA WIDIA P/ AFILAR VERDE**

- 020056 152 x 19 x 31 mm G-100
- 020060 152 x 25 x 31 mm G-120
- 020066 254 x 25 x 38 mm G-120



**PIEDRA CIRCULAR P/ ESMERILAR**

- 020029 127 x 25 x 31 mm G-36
- 020034 152 x 19 x 31 mm G-60
- 020040 203 x 25 x 31 mm G-60
- 020042 254 x 25 x 38 mm G-46
- 020047 304 x 38 x 38 mm G-24



**DISCO DE LIJA**

- 033263 4.1/2" G-100
- 033264 4.1/2" G-120
- 004498 7" G-16
- 004497 7" G-120



**DISCO DE PULIR/FLAP DISC**

- 088205 7 x 7/8" G-60
- 027328 3 x 1 x 1/4" G-80



**CINTA ANTIDESLIZANTE**  
Clear 2 Pulg x 20 M  
(008444)

- 020001 2 Pulg x 147.6 Pie G-50
- 020005 2 Pulg x 150 Pie G-120

**TELA DE ROLLO**





### PIEDRA COPA BLANCA

- 020020 5 x 2 x 1.1/4" G-46
- 038577 8 x 4 x 1.1/4" G-60



### PIEDRA BLANCA

- 020012 7 x 1/2 x 1.1/4" G-60
- 038575 6 x 1/2 x 1.1/4" G-80
- 013800 8 x 1 x 1.1/4" G-120



**LIJA PARA FERRE**  
G-36 Blanca / Amarilla  
(006596)

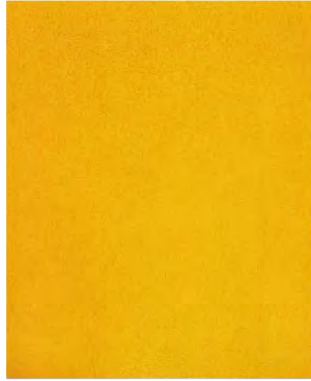

**LIJA AMARILLA**  
G-60 / G-125  
(006604)



### LIJA DE AGUA

- 014180 G-80
- 014191 G-600



### BANDA DE LIJA

- 058834 3 x 24" G-120
- 058827 4 x 24" G-80

### PIEDRA MONTADA

- 020029 127 x 25 x 31 mm G-36
- 020034 152 x 19 x 31 mm G-60
- 020040 203 x 25 x 31 mm G-60
- 020042 254 x 25 x 38 mm G-46
- 020047 304 x 38 x 38 mm G-24



# MAQUINA DE SOLDAR INVERTER



**200 Amp al 60% de ciclo de trabajo** (Suelta todos los electrodos incluyendo aluminio)  
(050416)



**T40.20PAH/TIG AC/DC**  
(052509)



**Potenza TIG de 170 Amp al 60% de ciclo de trabajo, Monofásica** (Equipo de alta frecuencia p/soldar inoxidable y aceros)  
(052512)



**Potenza 200**  
(050416)



**Multitensión 210 Amp 2100 PFC**  
(054646)



**Progress 1700 PFC bitensión**  
(050417)



**M40.20 MULTI/MIG 200 MULTI**  
(052510)





**PEDESTAL PARA TALADRO**  
60mm  
(050414)



**TALADRO-ATORNILLADOR**  
12V  
(067772)



**TALADRO PERCUTOR**  
12V  
(067773)



**CARETA DE SOLDAR**  
(050418)



**PULIDORA**  
110V  
(057406)



**ATORNILLADOR**  
110V/60Hz/1P  
(067775)



**TALADRO PERCUTOR**  
1/2" 110V/60Hz/1P  
(067776)



**SIERRA RADIAL**  
110/220V  
(058760)



**TALADRO MARTILLO DEMOLEDOR**  
110V/60Hz/1P HD  
(067777)



**CEPILLO PARA MADERA**  
(054640)



**INGLETEADORA TELESCOPICA**  
12" 110V  
(060985)



**DISCO DIAMANTE**

058764 Universal básico 4.1/2"



**DISCO PULIR METAL**

050427 Flap Procer 4.1/2" X 7/8"

054722 Flap Procer 7"

052516 7" X 1/4" X 7/8"



**DISCO CORTE CONCRETO**

050424 9"x5/64"x7/8"



**DISCO CORTE INOXIDABLE**

050421 4.1/2"x1/16"x7/8"

050422 7"x1/16"x7/8"





**SOLDADORA CA/CD**  
TH-235/160 max 225 Amp  
20% ciclo de trabajo  
(080741)



**SOLDADORA**  
TH-250  
(011689)



**MÁQUINA CORTE PLASMA**  
3/4" acero 1/2" aluminio  
220/440V HotPoint750  
(086016)



**SOLDADORA CA**  
TH-225 max 225 Amp  
20% ciclo de trabajo  
(080740)



**SOLDADORA CD**  
MI3-500/47 400 Amp  
ciclo de trabajo trifásico 220/440V  
(086340)



**SOLDADORA MONOFÁSICA**  
40% ciclo de trabajo  
CD 220/440V MI-2-300  
(084993)



**SOLDADORA TRIFÁSICO CD**  
500 Amp 60% ciclo de trabajo  
220/440V MI3-57  
(086341)



**SOLDADURA**

081648	Ferro-niquel 60-1/8"
088634	Acero 6013 - 1/8"x14"
081649	Eléctrica Aluminio 1/8"
095952	Acero básico 7018 - 3/32"
081647	Acero inox. 1/8"x14" 3.2mm



**SOLDADURA ALAMBRE  
ACERO ELECTRICO**

082463	0.035"
082464	0.045"





**PLANTA SOLDADORA CA/CD**  
de gasolina 250 Amp 100% ciclo  
de trabajo 18 HP Bronco-250  
(080742)



**SOLDADORA TIG AC/DC**  
250 Amp 50% ciclo de trabajo  
220/440V MI-2-300  
(089058)



**PLANTA SOLDADORA CD**  
de gasolina 140 Amp 60% ciclo  
de trabajo motor 110 HP Bronco-3700  
(089543)



**REGULADOR**  
para oxígeno  
Silver Star SH-1310-P  
(033783)



**REGULADOR**  
para acetileno  
SH-1320  
(033782)



**REGULADOR**  
para nitrógeno  
SH-1320  
(026918)



**REGULADOR**  
médico  
CGA-FCM-540-M  
(089544)



**CHALECO DE CARNAZA**  
para soldar #5647  
(026907)



**CARETA SOLDAR**  
fibra con vent  
móvil #8115  
(080748)



**SEGURIDAD**

- 1 026906 Guantes cortos de carnaza
- 2 026908 Mangas de carnaza
- 3 026909 Mandil de carnaza

**Equipo oxicorte dinámico**  
EQP-PL-003-V  
(032020)





**JUMPER / ARRANCADOR**  
compresor 12 V 750 Amp SJ1331  
(027973)



**CARGADOR AUTOMÁTICO**  
15 Amp 6/12V SC1360  
(059620)



**FUENTE DE PODER ARRANCADOR**  
para batería 22 Ah 12 V DSR114  
(059619)



**CARGADOR MANTENEDOR AUTOMÁTICO**  
10 Amp 12 V SC1339  
(061889)



**CARGADOR AUTOMÁTICO**  
2/10/50 Amp 12 V SC1361  
(061888)



**CARGADOR MANTENEDOR**  
1.5 A 6/12 V SC-1300  
(005455)



**ARRANCADOR CARGADOR MANTENEDOR**  
065524 275/40/6/2 Amp 6/12 V SC1326  
065523 250/50/6/2 Amp 6/12 V SC1325  
021456 250/275/60/20 A mp 12/24 V SC1352



**PROBADOR DE BATERÍAS**  
6/12/24 V  
(068941)



**PROBADOR DE BATERÍAS**  
12 V 100 Amp BT-100  
(021464)



**ABANICO PORTATIL**  
12V SAC-404  
(056006)



**VOLTI-AMPERIMETRO DE GANCHO DIGITAL**

004142 600A - 600V  
060757 TRMS 660A - 750V  
028085 1,200A - 1,000V



**VOLTI-AMPERIMETRO DE GANCHO DIGITAL**

080515 1,000A - 750V  
082100 1,200AC/DC 750V  
080532 600A - 600V



**VOLTI-AMPERIMETRO DE GANCHO DIGITAL**

AC/DC Watt  
TRMS 600A - 600V  
(016877)



**VOLTI-AMPERIMETRO DE GANCHO DIGITAL**

094413 400A - 600V  
092977 600A - 600V  
027703 400A - 600V



**MULTITESTER DIGITAL**

016878 0.01 - 10A 600VRMS  
038000 0.01 - 10A TRMS 1000V



**MULTITESTER DIGITAL INSULADO**

600V 3MΩ  
(016444)



**MULTITESTER DIGITAL**

750V - 200MA - 10A  
(080530)



**MEDIDOR DE CAPACITORES DIGITAL**

20MP - 200PP  
(016447)



**INDICADOR DE NIVEL DE SONIDO**

30 - 130 dB  
(080526)



**MEDIDOR DE LUZ DIGITAL**

004140 20 - 200,000 Lux  
004141 20 - 200,000 Lux



**TERMÓMETRO DIGITAL**

200 °C - 1,370 °C  
328 °F - 1,922 °F  
(004139)



**TERMÓMETRO INFRAROJO**

30 °C - 350 °C  
22 °F - 986 °F  
(016879)





**BOMBA HEAVY DUTY**

055916 12 V

055917 115 V

**BOMBA DE ENGRASE**  
depósito 11 Lbs manguera 1.5 M  
(015753)



**PRENSA PARA CARPINTERO**

009397 36" 900mm

009431 60" 1500mm

009442 84" 2100mm



**PRENSA DE BANCO ACERO**

009128 4" 100mm

009129 6" 150mm

009136 8" 200mm



**MEDIDOR DE COMBUSTIBLE 1"**  
(028080)



**BOMBA DE ENGRASE**  
depósito 50 Kg con ruedas  
(035014)



**BOMBA DE ENGRASE**  
depósito 22 Lbs  
manguera 2 M  
(015766)



**BOMBA MANUAL**  
rotativa profesional 1"  
(009479)



**BOMBA MANUAL**  
para tanque químico  
(015760)



**BOMBA NYLON**  
para químicos 400 ml  
(009459)

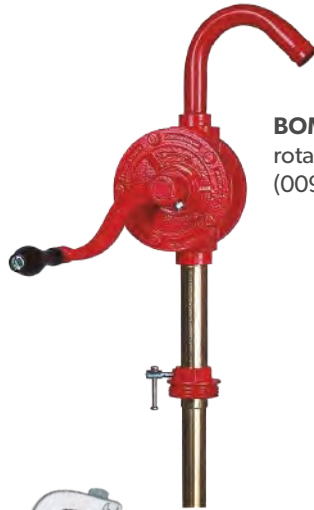

**BOMBA MANUAL**  
rotativa 1"  
(009466)



**ENGRASADORA NEUMÁTICA**  
de 120lbs / 60kg / 16gl  
(009467)



**PISTOLA PARA GRASA**  
con booster  
(030264)



**PISTOLA PARA GRASA**  
profesional  
(030263)



**ENGRASADORA DE MANO**  
500 CC 10mm  
(015752)



**PISTOLA PARA ACEITE**  
con medidor  
(030265)



**PISTOLA PARA COMBUSTIBLE**  
con medidor 3/4"  
(035015)



**PISTOLA PARA COMBUSTIBLE 3/4"**  
(035016)





**COMPRESOR ROTATIVO DE TORNILLO**

- 029053 5HP c/tanque de 80 gals
- 028343 7.5HP c/tanque de 80 gals
- 029054 10 HP c/tanque de 80 gals
- 028344 25HP c/tanque de 120 gals



**COMPRESOR**  
Para odontólogos  
1.5 HP con tanque  
10 gal  
(039569)



**COMPRESOR VERTICAL**  
7.5 HP 80 gal  
(054598)



**JUEGO 4 CONECTORES  
RAPIDOS AIRE**  
(021434)



**LLAVE DE  
IMPACTO**  
1/2"  
(029050)



**TALADRO  
DE AIRE**  
1/2"  
(086968)



**PULIDORA NEUMATICA 5"**  
(086460)



**LLAVE DE IMPACTO**  
(029051)



**GRAPADOR /  
CLAVADORA  
NEUMATICA**  
(056869)





**MAQUINA LAVADO A PRESION**  
4200 PSI  
(056866)



**INFLADOR DE GOMAS**  
Con manómetro presión  
y luz led 12 V  
(058874)



**COMPRESOR**  
2 HP 20 gal  
(099218)



**SANDBLASTER**  
Arena 9 gal  
(081323)



**PISTOLA PULVERIZADORA DE GRAVEDAD**  
(061792)



**REMACHADORA NEUMATICA**  
(028345)



**PISTOLA**  
De alta Presión  
(021424)



**CONJUNTO FILTRO**  
Regulador y lubricador  
(089924)



**MANGUERA**  
1/4" x 50" Espiral  
(021443)



**ACEITE DE COMPRESOR**  
(050967)



**MANGUERA**  
3/8" x 25' azul 300 PSI  
(098003)





**COMBO  
BOMBA SUCCIÓN  
LADRONA 0.5 HP  
+ SWITCH ELECTRÓNICO  
(014757)**



**BOMBA  
DOBLE SUCCIÓN  
1 HP 110 / 220 V  
(052837)**



**BOMBA JET**

096395	0.5 HP 110V/220 V
096396	3/4 HP 110/220 V
096397	1 HP 110/220 V
096398	1.5 HP 220 V
096399	2 HP 220 V



**BOMBA CENTRÍFUGA  
De presión para cisternas**

099668	3 HP 220 V
000964	4 HP 220 V



**BOMBA  
Acero inoxidable  
1 HP 110/220 v  
(096400)**



**BOMBA  
SUMERGIBLE  
Para fuentes  
0.5 HP  
Inoxidable 110 v  
(096391)**



**GRIFO  
Cuello Cisne  
para filtro  
(026930)**

**ESTERILIZADOR  
UV de agua  
2 GPM  
(031445)**



**BOMBA SUMERGIBLE  
Para fuentes  
0.33 HP 110 v  
(010928)**

**HOUSING  
PARA FILTRO  
4.1/2" x 20"  
Transparente  
(037813)**



**HOUSING  
PARA FILTRO  
4.1/2" x 20"  
(099564)**



**HOUSING  
PARA FILTRO  
4.1/2" x 10"  
(099563)**



**HOUSING  
PARA FILTRO  
2.1/2" x 10"  
Transparente  
(099561)**



**CARTUCHO  
Hilo  
4.1/2" X 20"  
(099572)**



**CARTUCHO  
Hilo  
2.1/2" x 20"  
(009904)**





**BOMBA**  
Para jacuzzi  
0.65 HP  
(029593)



**BOMBA PISCINA**  
3 HP 220 V  
(015006)



**BOMBA 0.5 HP + TANQUE PRESURIZADO**  
19 lt vertical  
(C0620)



**BOMBA CENTRÍFUGA**  
De presión para cisternas

052834	5.5 HP 220 V / 3 fases
052835	7.5 HP 220 V / 3 fases
052836	10 HP 220 V / 3 fases



**TANQUE DE AGUA**  
En fibra precargado

081539	20 gal
081540	35 gal
081541	50 gal
010927	65 gal



**FILTRO OSMOSIS RESIDENCIAL**  
50 GPD. C/ UV  
(009926)



**BOMBA 0.5 HP + TANQUE PRESURIZADO ANTICORROSIÓN**  
24 lt + Accesorios  
(014401)



**BOMBAS SUMERGIBLES**

098927	3/4 HP 220 V
098928	1 HP 220 V
098929	1.5 HP 220 V
098930	2 HP 220



**CARTUCHO Hilo**  
2.1/2" x 10"  
(099574)



**FILTRO Polipropileno**  
4.1/2"x20"  
(002729)



**CARTUCHO Sedimento**  
2.1/2"x20"  
(009903)



**CARTUCHO Sedimento**  
2.1/2"x10"  
(023674)



**FILTRO Carbón Sedimento**  
2. 1/2" x 10"  
(009907)



**FILTRO De línea**  
(099583)



**MOTOR DIESEL MULTIPLE**

039138 20HP

039139 22HP

**MOTOR**

050443 Gasolina 6.5HP

057437 Diesel 6.6HP

**VIBRADOR ELECTRIC PARA CONCRETO c/manguera**

057441 1.1/2" 3HP

057442 2" 3HP

**COMPACTADOR**

057435 Motor diesel

057436 Motor gasolina Honda

**MOTOBOMBAS**

039140 Diesel 2"

039141 Diesel 3"

039142 Diesel 4"

050445 Gasolina 2"

050446 Gasolina 3"

**VIBRADOR PARA CONCRETO MOTOR GASOLINA c/manguera**

057439 1.1/2" 5.5HP

057440 2" 5.5HP

**HELICOPTERO PARA ALISAR CONCRETO**

052652 36"

050444 40"

039137 47"

**CORTADORA DE ASFALTO Y CONCRETO**

 Motor Honda 15 HP Gasolina  
(064326)



**CEPILLO**

- 039026 12" 2.2KW 220V
- 039025 6" 1HP 110V



**SIERRA DE BANCO**

- 039032 10" 2200W 220V-110V
- 039033 12" 2200W 220V-110V



**HORMIGONERAS REMOLCABLES SM450**

- C0738 Motor gasolina 6.5HP Excalibur
- C0745 Motor diesel 6.6HP Excalibur
- C0737 Motor gasolina 5.5HP Honda



**MAQUINA COMBINADA**  
1.50Kw 220V  
(039030)



**REGRESADORA**  
2HP 220V  
(039031)



**LIJADORA**  
250W 110V  
(039028)



**SIERRA SIN FIN**  
18" 2200W 220V  
(039035)



**LIJADORA**  
550W 110V  
(039029)



**FURADOR**  
750W 110V  
(039027)



**TALADRO DE MESA**  
375W 110V  
(039036)

**TALADRO PEDESTAL**  
375W 110V  
(039037)  
HD 1100W 110V  
(039038)



**SIERRA DE BANDA**  
21" 5HP 230V/60Hz/1P  
(068978)



**SIERRA SIN FIN**  
Horizontal 5" x 6"  
(054063)

**RECOLECTOR DE POLVO**  
1.5HP 110V 1P  
(039899)



**REGRESADORA**  
5HP 220V/60Hz/1P  
(068462)



**SIERRA DE BANCO**  
10" 3HP  
(067074)



**CEPILO DE MESA**  
6"  
(054062)

**TALADRO DE PEDESTAL**

062086 13" 3/4HP

068876 20" 1.5HP



**SANDBLASTER PORTABLE**  
20 gls  
(068974)





**GANCHO PARA CADENA**

069202 10mm  
069203 13mm



**GANCHO DE SEGURIDAD GIRATORIO**

073022 10mm  
073023 13mm



**GRILLETE DE ALTA RESISTENCIA**

069208 1/2" 2T  
069209 3/4" 4.75T  
069210 1" 8.75T



**GANCHO DE AGARRE CLEVIS**

073024 10mm  
073025 13mm  
073026 16mm



**MORDAZA UNIVERSAL**

2T (0-25mm)  
(069217)



**ENLACE DE CONEXIÓN TIPO EUROPEO**

073003 10mm  
073004 13mm  
073005 16mm  
073006 20mm



**GANCHO DE SEGURIDAD CLEVIS**

073018 13mm  
073019 16mm  
073020 18mm  
073021 22mm



**GRAPA PARA JALAR CABLE**

2T (2-26mm)  
(069206)



**ENLACE SUB-MASTER**

073007 10mm  
073008 13mm



**ENLACE DE CARGA TIPO CHICHARRA**

073011 5/16" - 3/8"  
073012 3/8" - 1/2"  
073013 1/2" - 5/8"



**PLATAFORMA FIJA**

12T  
(069220)



**PLATAFORMA MÓVIL**

12T  
(069222)



**ENLACE DE CARGA ESTANDAR**

073009 5/16" - 3/8"  
073010 3/8" - 1/2"



**CARRETILLA HIDRÁULICA**

2.5Tx550mm  
(069180)



**GRÚA PLEGABLE**

069213 2T (85-2000mm)  
069214 3T (0-2000mm)



**ESCALERA TIJERA FIBRA DOBLE**

069194 4' 072995 8'  
069195 5' 072996 10'  
069196 6' 072997 12'  
069197 7' 072998 14'



**ESCALERA TELESCÓPICA PLEGABLE**

073014 8.5'  
073015 9.5'  
073016 10.5'  
073017 12.5'



**ESCALERA EXTENSIÓN**

072999 20'  
073000 24'  
073001 28'  
073002 32'



### DIFERENCIAL ELÉCTRICO

- 038190 1 ton 30' alzada 220/60/1
- 038191 2 ton 30' alzada 220/60/1
- 038192 3 ton 30' alzada 220/60/1
- 050516 2 ton 30' alzada 220/440/60/3
- 050517 3 ton 30' alzada 220/440/60/3
- 038193 5 ton 30' alzada 220/440/60/3
- 065289 7.5 ton 30' alzada 220/440/60/3
- 065290 10 ton 30' alzada 220/440/60/3



### DIFERENCIAL DE CADENA MANUAL

- 050518 0.5 ton 10' alzada
- 050519 1 ton 10' alzada
- 050520 1.5 ton 10' alzada
- 054504 2 ton 10' alzada
- 050521 3 ton 10' alzada
- 050522 5 ton 10' alzada
- 038194 10 ton 10' alzada



### CADENA DE CARGA

8 mm x 24 mm grado  
80 AW-80-08  
(050550)

### CADENA DE MANO

5 mm x 23.7 mm CB-B  
(052746)



### DIFERENCIAL ELÉCTRICO DE CABLE

con trolley 3 ton 12M alzada  
220V/60/3  
(065290)



### WINCHE ELÉCTRICO DE CABLE

- 065291 500Kg 110V/60Hz/1P
- 065292 1000kg 110V-220V/60Hz/1P



### PULLER PALANCA

- 050523 0.75 ton
- 050524 1.5 ton

### PULLER DE CABLE

1.5 ton HRP015  
(050549)



### TROLLEY ELÉCTRICO PARA DIFERENCIAL

- 050525 3 ton 220/440/60/3
- 050526 5 ton 220/440/60/3



### TRACTEL DE CABLE

- 054508 0.8 ton x 20 M WRP08
- 050532 1.6 ton x 20 M WRP16
- 050533 3.2 ton x 20 M WRP32
- 058285 5.4 ton x 20 M WRP54



### TROLLEY PARA DIFERENCIAL

- 050527 0.5 ton
- 050528 1 ton
- 050529 2 ton
- 073027 3 ton



### TROLLEY DE CADENA PARA DIFERENCIAL

- 050530 5 ton
- 050531 10 ton



### WINCHE DE FRENO MANUAL

- 054505 1200 Lbs 10 M cable
- 054506 1800 Lbs 10 M cable
- 054507 2600 Lbs 10 M cable



**EQUIPO SOLDAR Y CORTAR**  
#0384-2036  
(024739)



**EQUIPO DE CORTAR**  
#0384-2060  
(010767)



**REGULADOR DE OXÍGENO**  
2.1/2" HD #0781-0527  
(021724)



**REGULADOR DE ACETILENO**  
2.1/2" HD #0781-0584  
(007568)



**REGULADOR DE ACETILENO**  
#0781-9420  
(017536)



**REGULADOR DE OXÍGENO**  
#0781-9415  
(017537)



**BOQUILLA PARA CORTAR  
CON GAS PROPANO**

- 021719 #1 1-GPN
- 021720 #2 2-GPN
- 021721 #3 3-GPN
- 010755 #4 4-GPN
- 001930 #5 5-GPN
- 015013 #6 6-GPN



**BOQUILLA PARA CORTAR  
CON OXI-ACETILENO**

- 021716 #1 #1-101
- 021717 #2 #1-101
- 021718 #3 #1-101
- 010752 #4 #1-101



**ANTORCHA PARA CORTAR**  
21" 0381-1480  
(000619)



**JUEGO ARRESTA LLAMA**  
2/1 para regulador  
VIC-0656-0007  
(027116)



**JUEGO ARRESTA LLAMA**  
2/1 para antorcha  
VIC-0656-0006  
(027115)



**MANGUERA DOBLE PARA  
ACETILENO**

- 096877 1/4" x 50' RH-2103
- 096876 1/4" x 25' RH-2102
- 099176 1/4" x 100' RH-2105



**EQUIPO PARA SOLDAR Y CORTAR**  
Portátil con tanques 0384-0936  
(024741)





**SIERRA DE BANDA**  
110V/60Hz/1P  
(071260)



**CORTADOR/DOBLADOR DE VARILLAS**  
1" 110V/60Hz/1P  
(071257)



**TALADRO MAGNÉTICO**

- 065554 5/8"
- 065555 1.1/8"
- 071255 3/4" 110V/60Hz/1P



**JUEGO TERRAJAS MANUAL**

- 059571 3/8" a 1.1/4" NPT
- 059572 3/8" a 2" NPT



**MÁQUINA DESTAPAR TUBERÍAS**  
3/4" a 6" 110V/60Hz/1PH  
(059576)



**DESTUPIDOR TIPO TALADRO**  
3/4" 2.1/2" 110V/60Hz/1P  
(071256)



**PLANCHA PARA SOLDAR TUBERIA**

- 059584 PPR 2"
- 071254 PPR 4" 220V/60Hz/1P



**CORTADORA DE TUBOS**  
1/8" a 2"  
(059580)



**SOPORTE PARA TUBOS 12"**  
(059578)



**PRENSA PARA TUBOS**  
1/8" a 6"  
(065564)



**PRENSA PARA TUBOS**  
1/8" a 2"  
(059581)



**CORTADOR/PERFORADOR**  
(065553)



**ROSCADORA**

- 059564 1/2" a 2" NPT 110V/60Hz/1PH
- 059565 1/2" a 3" NPT 110V/60Hz/1PH
- 059566 1/2" a 4" NPT 110V/60Hz/1PH



**RANURADORA HIDRÁULICA**  
2" a 6" y 8" a 12"  
(059575)



**DOBLADOR HIDRÁULICO DE TUBOS**  
1/2" a 2"  
(059583)



**ALICATE DE CORTE**  
diagonal 8  
(083315)



**PINZA CORTACABLES**  
9" #509  
(000622)



**PINZA DE ELECTRICISTA**  
jalaguia 9" D215-9  
(075487)



**ALICATE ELÉCTRICO**  
HD 9" KT201-9  
(020964)



**CORTACABLES**  
10" sist. matraca  
#5750  
(008091)



**LLAVE AJUSTABLE**  
(1000V Cromada con mango T aislado)  
000628 10"  
075488 12"



**ALICATE ELÉCTRICO**  
9" Aislado 1000V  
KTA201-9  
(083316)



**PINZA PELA ALAMBRES**  
automática cal.  
10-22  
(000630)



**CUCHILLA PELADORA CURVA**  
007907 A1570-3  
083320 #1570-3



**JUEGO DE LLAVES HEXAGONALES**  
13/1 con punta bola  
#717  
(075492)



**TIJERAS**  
industriales y/o  
sastre 8" #505-8  
(075493)



**LLAVE ALLEN**  
(con mango T aislado)  
075489 1/4"  
075490 5/16"  
075491 3/8"



**GUÍAS JALACABLES**  
(Alambre Plano)  
000633 1mmx3mmx30M  
000634 1mmx3mmx15M



**DOBLADOR DE TUBOS**  
1/2" #12-50  
(083321)



**BANDOLA LINIERO**  
c/gancho y doble  
seguro #5295-16D  
(018013)



**ARNÉS DE CUERPO COMPLETO**  
#5435  
(083317)



### ARRANCADOR/JUMPER DE BATERÍAS

12/24V Litio 12/24V  
9000/4500A 110/220V  
Startzilla 9024 XT  
(043797)

12V 4000A 110/220V  
Startzilla 4012 XT  
(043796)

### PROBADOR DE BATERÍAS

12V  
BTS350  
(043798)

12V  
compatible USB  
STS 700  
(043799)



### CARGADOR/MANTENEDOR DE BATERÍAS



6/12V 0.75A 110/220V  
Defender 8  
(043787)

### ARRANCADOR/JUMPER DE BATERÍAS

12V 1000A  
Cargador tipo C  
de 1000 mAh  
Drive Mini 12  
(043792)

12V 1200A  
110/220V  
Drive 9000  
(043793)

12V 2000A  
110/220V  
Drive Pro 12  
(043794)

12/24V 2200A  
110/220V  
Drive Pro 12/24  
(043795)

### CARGADOR/MANTENEDOR DE BATERÍAS



6/12V 4A 110/220V  
T-Charge 12 Evo  
(043789)



12/24V 8/4A 110V  
T-Charge 20 Evo  
(043790)



12/24V 16/8A 110V  
T-Charge 26 Evo  
(043791)



12/24V 8/4A 110/220V  
Defender 20  
(043788)





**ASPIRADORA DE POLVO**  
1 gal 1 HP Potencia Pico (PHP)  
(059520)



**ASPIRADORA DE POLVO**  
2.5 gal 2 HP  
(059522)



**ASPIRADORA DE POLVO**  
5 gal 2 HP  
(059524)



**ASPIRADORA DE POLVO**  
12 gal 5.5 HP  
(059526)



**ASPIRADORA DE POLVO**  
14 gal 6.5 HP  
(059519)



**ASPIRADORA DE POLVO  
ACERO INOXIDABLE**  
12 gal 5.5 HP  
(071560)



**ASPIRADORA DE POLVO  
ACERO INOXIDABLE**  
8 gal 4 HP  
(062242)



**BOLSA REPUESTO  
REUSABLE 3/1**  
(090971)



**FILTRO PARA  
ASPIRADORAS**  
030003 #9030436  
069491 #90398



**FILTRO FOAM PARA  
ASPIRADORA**  
030004 #9058536  
056061 #905-26-36



**MANGUERA ASPIRADORA**  
067449 8Pie x 1.25Pulg  
067450 8Pie x 2.1/2Pulg



**BOLSA DE REPUESTO 3/1**

039112	1-1.5 gal
059523	2-2.5 gal
036925	10-14 gal
045967	15-22 gal



## HORMIGONERA REFORZADA BT 400 SR

(097867)

### MOTOR DE GASOLINA

 **HONDA** GX 160  
5,5 hp

 <b>DOSIS</b>	35 Kg + 35 Kg	 <b>CAPACIDAD DEL TROMPO</b>	360 L
 <b>SIN MOTOR</b>	168Kg	 <b>MÁX. DE MEZCLA</b>	290 L
 <b>PRODUCCIÓN POR HORA</b>	2,60 m <sup>3</sup> /h	 <b>DIMENSIONES</b>	1810 x 1100 x 1650 mm

## HORMIGONERA REMOLCABLE BP 400 RLAT EVO

(097868)

### MOTOR DE GASOLINA

 **HONDA** GX 160  
5,5 hp



 <b>CANTIDAD</b>	1 funda de 42 Kg + 1 funda de 28 Kg	 <b>CAPACIDAD DEL TROMPO</b>	360 L
 <b>SIN MOTOR</b>	251 Kg	 <b>MÁX. DE MEZCLA</b>	290 L
 <b>PRODUCCIÓN POR HORA</b>	2,60 m <sup>3</sup> /h	 <b>DIMENSIONES</b>	1800 x 1100 x 1600 mm



**EQUIPO DESABOLLADOR  
HIDRÁULICO**  
10 ton GC-10  
(084146)



**CILINDRO SIMPLE**  
31 ton retorno por  
muelle CSRA-31B  
(098965)



**CILINDRO SIMPLE**  
31 ton retorno por  
gravedad CSB-31B  
(097775)



**CILINDRO EXTRAPLANO**  
55 ton CSE-55  
(013338)



**GATO HIDRÁULICO  
TIPO RANA**

085597 2 ton  
024222 10 ton  
060787 20 ton



**BOMBA MANUAL**  
400cc BM-04  
(094398)



**GATO HIDRÁULICO  
PARA TRANSMISIONES**

hasta 1 ton GCB-2  
(081055)



**GATO HIDRÁULICO  
BOTELLA**

005430 10 ton  
005433 20 ton  
005439 50 ton



**DOBLADOR HIDRÁULICO  
DE TUBOS**  
20 ton 3Pulg DR-3  
(021978)



**GRÚA PLEGABLE**  
1 ton CRV10  
(021501)



**PRENSA HIDRÁULICA**

039555 20 ton cilindro fijo PRC20  
085593 30 ton KPD-30  
085594 50 ton KPD-50





### SIERRA SIN FÍN

Para cortar carne 5/8"  
(096085)

### SIERRA CINTA DE ACERO

Para madera 2"x0.55"x3th  
(096085)

### ROLLO SIERRA CINTA DE ACERO FLEX-BACK

072080 3/4"x0,032"x8T

072079 1"x0,035"x8T



### SEGUETA BI-METÁLICA

084817 1/2"x18th

026535 1/2"x24th

026536 1/2"x32th



### SEGUETA PARA MÁQUINA

098435 12"x1"x 14Th

096655 14"x1"x10th

084836 17"x1.1/4"x6th

084838 18"x1.1/2"x6th



### CALIBRADOR PIE DE REY

096244 0-200mm - 0-8"

096245 0-300mm - 0-12"



### CALIBRADOR PIE DE REY

6" con reloj  
(096231)



### PILOTE SIERRA

A1  
(096106)

### PILOTE SIERRA

A2  
(096107)



### COMPÁS PARA METAL

exterior 6"  
(096236)



### COMPÁS PARA METAL

de punta 6"  
(096239)



### MICRÓMETRO

096201 0-25 mm

096202 25-50 mm

014839 3"-4"



### BURBUJA TRANSVERSAL

para nivel 200mm - 8"  
(069322)



### SIERRA COPA

(Gran variedad)

096092 3/4"

095634 1"

096248 2"

096101 3"

037235 4.1/2"



### JUEGO DE SIERRAS COPA

(030709)



**CEPILLO COPA DE ACERO**

- 020135 3"x5/8"
- 020136 4"x5/8"
- 020137 5"x5/8"
- 095180 6"x5/8"



**CEPILLO COPA TRENZADO**

- 016315 3"x5/8"
- 020138 4"x5/8"
- 020139 5"x5/8"



**CEPILLO CIRCULAR DE ACERO**

- 020130 5"x1" x1/2"
- 020131 6"x1"x5/8"
- 016312 6"x1"x5/8" inox.
- 020132 8"x1.1/8"x3/4"
- 020133 10"x1.3/8"x3/4"



**CEPILLO CIRCULAR DE NYLON**

- 016313 6"-4H
- 016314 6"-8H



**CEPILLO CIRCULAR CON EJE DE 1/4**

- 020148 2"
- 020150 3"
- 000130 4"



**CEPILLO CON EJE DE 1/4**

- 020151 2"
- 020152 3"



**CEPILLO CIRCULAR DE ACERO TRENZADO**

- 6"x7/8"x5/8"
- (020134)



**CEPILLO CIRCULAR CON EJE DE 1/4**

- 020140 #1
- 020143 #4
- 020144 #5



**CEPILLO PARA LIMPIAR TUBOS**

- 020153 1/4" y 3/4"
- 020154 1.3/16"
- 020155 2"
- 020156 3"



**CEPILLO FIBRA FINA INOXIDABLE**  
con mango plástico  
(084930)



**CEPILLO FIBRA FINA ACERO**  
con mango plástico  
(084929)



**CEPILLO DE ACERO**  
con mango de madera  
(020127)



**DIFERENCIAL**

021471	1/2 ton con 8 1/2' alzada
021472	1 ton con 8 1/2' alzada
080791	1.1/2 ton con 8.1/2' alzada
080792	2 ton con 10' alzada
080793	3 ton con 10' alzada
080794	5 ton con 10' alzada
080795	10 ton con 10' alzada



**TROLLEY**

016019	1 ton
016020	2 ton
061732	5 ton Plain
080801	5 ton
015339	10 ton



**CADENA DE CARGA**

021481	6.3mm x 19.1mm
021482	7.1mm x 21.0mm
086095	7.9mm x 23.0mm
086096	9mm x 27.0 mm



**PULLER (Come Along)**

080796	0.8 ton 5' alzada
080797	1.1/2 ton 5' alzada
080798	3 ton 5' alzada
080799	6 ton. 5' alzada



**TRACTEL DE CABLE (WINCHE)**  
6 ton  
(021473)





**EXTRACTOR EN LINEA**  
BOX BV 7/7 -25/25  
0.25 - 11 KW  
1000 - 21194 CFM



**EXTRACTOR INDUSTRIAL  
DE AIRE PARA PARED**  
HJB 110 - 120  
0.75 - 1.1 KW 19022 - 22830 CFM



**EXTRACTOR DE AIRE  
PARA TECHO**  
BT ROOF 200 - 315  
0.205 - 0.413 KW 670 - 1324 CFM



**EXTRACTOR DE AIRE  
PARA TECHO**  
CTH2 400 - 800  
0.55 - 5.5 KW 3001 - 17472 CFM2

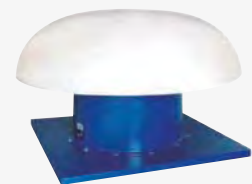

**EXTRACTOR DE AIRE  
PARA TECHO**  
HMTE 25 - 80 0.08 - 4 KW  
701 - 18222 CFM



**EXTRACTOR EN LINEA**  
CHELYS 100 - 250  
0.03 - 0.17 KW  
123 - 673 CFM



**EXTRACTOR DE AIRE  
PARA BAÑO**  
LARUS 4" - 5" 14.1 - 16.7 W  
62 - 94 CFM



**EXTRACTOR DE AIRE  
PARA BAÑO**  
LIBELLUM 4" 13 W 64 CFM



**TURBINA EJE LIBRE**  
Sin motor  
BV 7/7 - 12/12



**EXTRACTOR DE AIRE PARA PARED**  
HBJM PLUS 30 - 50 0.12 - 0.25 KW  
1560 - 4267 CFM



**EXTRACTOR CENTRIFUGO**  
MA 26 - 31 0.55 - 2.2 KW  
235 - 1277 CFM

# KÖNIN



**TELEVISOR LED  
4K FHD 55"**  
3 HDMI  
2 USB  
(057527)

**TELEVISOR LED  
FULL HD 43"**  
Ultra Slim  
2 HDMI  
3 USB  
(064000)

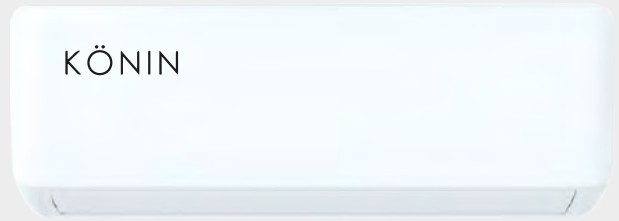

## KÖNIN

**ACONDICIONADOR  
DE AIRE**  
12,000 BTU (000710)      24,000 BTU (052021)

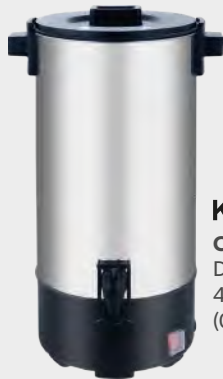

**Kitchen PRO  
CAFETERA ELÉCTRICA**  
De aluminio  
40 tazas - 95W  
(068098)



**Galanz**  
**NEVERA  
EJECUTIVA**  
4.5 pies cúbicos  
Con llave  
Negro /Gris  
(050065)



**BEBEDERO**  
Blanco  
De sobre mesa  
Termoeléctrico  
(061268)



**Kitchen PRO  
BEBEDERO**  
Color plateado  
Agua fría, normal y  
caliente  
Botellón oculto  
(068757)



### Hamilton

**ABANICO DE PARED**  
20" - 1530 RPM      26" - 1350 RPM  
100 w - Giratorio      160 w - Giratorio  
(051161)      (051162)  
30" - 1400 RPM  
230 w - Giratorio  
(051163)



### Hamilton

**ABANICO DE PEDESTAL**  
20"  
1400 RPM 140 w  
Giratorio  
(051164)  
26"  
1400 RPM 190 w  
Giratorio  
(051165)  
30"  
1400 RPM 230 w  
Giratorio  
(051166)







PALETIZACIÓN CONVENCIONAL



- Seguridad y Fiabilidad
- Máximo aprovechamiento del espacio
- Diseño adaptable a distintos productos, pesos y dimensiones
- Solución optimizada para picking y paletización para cargas ligeras y pesadas, sin tornillos y con perfecto acabado

MINI-RACK SL 6,000



ECO SL 4,000



RANURADO





## Paletas Plásticas

• 40" X 48"

- MAXIMIZA TU LOGÍSTICA DE ENVÍOS Y RETORNOS DE MERCANCÍA
- REDUCE TUS COSTOS DE EMBALAJE

**PROHIGIÉNICA  
ENTRADA LIBRE**  
(065196)



Sistema de Protección  
Doble Pared

Diseño Único

**DOBLE PATA**  
(058731)

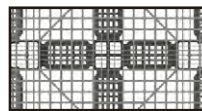

Diseño higiénico



6" HD / 5" SD

**APILABLE**  
(058732)



**APILABLE  
Para trabajos ligeros**  
(078951)

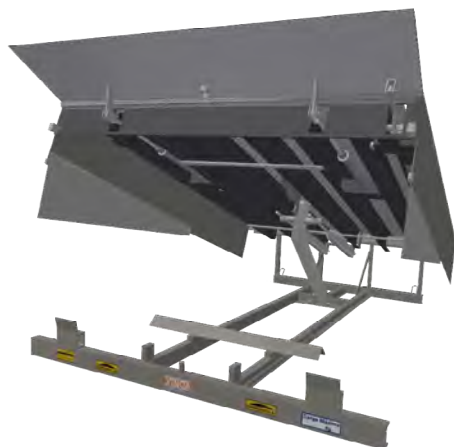

**MUELLE DE CARGA**  
(047388)

- 1,800mm x 2,495mm
- 6,000 Kg

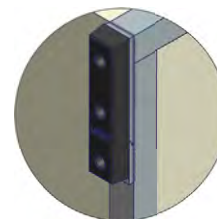

**TOPE DE GOMA**  
(047389)

- 400mm x 80mm

# SEGURIDAD



**CERRADURA**  
Dural  
Para puerta  
(011459)



**CERRADURA**  
Dural  
Para puerta  
Con llave  
(059745)



**CERRADURA**  
Dural  
Para puerta  
(059749)



**CIERRAPUERTAS**  
(002927)



**CERRADURA DE CONJUNTO**  
Entrada principal  
(050220)



**CERRADURA**  
Dural  
Eléctrica  
Izquierda  
(025783)



**CERRADURA**  
Sobreponer  
Derecha  
(027991)  
Izquierda  
(027992)



**BARRA ANTIPÁNICO**  
60 - 100 cm  
(031888)



**CANDADO**  
110-60 (002422) 110-50 (002421) 110-40 (002420)



**CANDADO**  
Dural  
Cuello largo  
50 mm  
(096126)



**CERRADURA TÁCTIL**  
• Con manilla  
• En idiomas: Español e Inglés  
• Hasta 25 usuarios con claves diferentes  
• Sonido interno  
(017076)



**MIRILLA DIGITAL 110°**  
• Para puertas 32 a 50 mm  
• Baterías AA incluidas (4)  
• Almacena 6,000 fotos con tarjeta microSD 512Mb (incluida)  
(051236)



**CAJA PARA LLAVES**  
48 unidades  
250 x 180 x 80 mm  
(019095)  
93 unidades  
300 x 240 x 80 mm  
(019096)



**CAJA CHICA**  
90 x 200 x 160 mm  
YFC-20  
(026496)  
90 x 200 x 180 mm  
YFC-25  
(026497)  
90 x 300 x 240 mm  
YFC-30  
(026498)



**CAJA FUERTE**  
990 x 600 x 610 mm  
(019088)



**CAJA FUERTE**  
Deposito  
DP60  
(039096)



**CAJA FUERTE**  
14" x 10" x 10"  
EUD25  
(039094)

16" x 9" x 13"  
EUD23  
(039093)

12" x 8" x 8"  
EUD20  
(039092)



**CINTA AMARILLA PRECAUCIÓN**  
3" x 250 m  
(018577)



**CASCOS PLÁSTICOS**  
Ajustables  
Varios colores  
(002514)



**ESPEJO ESFÉRICO**  
180°  
(018574)



**ESPEJO ESFÉRICO**  
360°  
(018575)



**FAJA SOPORTE**  
Tallas M-L-XL  
(082459)



**TRAJE DE AGUA**  
2 piezas  
Size M, L, XL  
(030472)



**CORREA ESLINGA**  
Para carga  
3" x 4 m 3000 kg (030460)  
4" x 5 m 4000 kg (030461)



**ARNÉS DE SEGURIDAD**  
(030457)

**AMORTIGUADOR DE CAÍDA**  
Línea de vida  
(015631)



**CINTURÓN DE SEGURIDAD**  
(002980)



**CORREAS DE AMARRE PARA CARGA**

1" x 5 m 750 Kg (015623)	1.1/2" x 10 m 3000 Kg (030459)	2" x 15 m 5000 Kg (015626)	3" x 15 m 7500 Kg (083716)
--------------------------------	--------------------------------------	----------------------------------	----------------------------------



**REDUCTOR DE VELOCIDAD**  
Corrugado  
De goma  
49 x 42 cm  
(029724)

**TERMINAL**  
Reductor de velocidad  
(029725)



**TOPE (PARACHOQUES)**  
Con panel reflectivo  
(034204)



**TOPE**  
Para parqueo  
Fibra plástica  
180 cm  
(018567)



**BARRA**  
para cono de tráfico  
120 cm  
(018576)

**CONO**  
Para tráfico PVC  
75 cm  
flexible al impacto  
(018579)



**PROTECTOR**  
De esquina  
80 x 10 x 1 cm  
(018569)



**POSTE**  
Flexible plástico  
80 cm  
(018570)



**CONO ROJO**  
Para tráfico con banda reflectiva y base de goma  
45 cm  
(051383)



**MALLA**  
Para construcción  
42" x 164'  
(013818)





**DISPENSADOR**  
Para jabón líquido  
Blanco (051846)  
Negro (051847)

**DISPENSADOR  
DE PAPEL TOALLA**  
(013583)

**DISPENSADOR  
DE SERVILLETAS**  
Blanco (051844)  
Negro (051845)

**DISPENSADOR  
DE PAPEL**  
Jumbo  
Blanco (051842)  
Negro (051843)



**PAPELERA  
INOXIDABLE**  
5 Lt (031917)    12 Lt (031918)

20 Lt (031919)    30 Lt (031920)

**EKO** SENSIBLE  
ECO  
LIVING



**ESPEJO 50''x  
70'' +SET DE  
ACCESORIOS 6/1**  
Cromo  
(C0706)



**LAVAMANOS**  
Con pedestal  
Blanco  
(096680)  
(008380)

**ORGANIZADOR**  
Para baño  
Cromo  
(008318)

**INODORO**  
Con tapa  
Blanco  
(032252)

**BOTIQUÍN**  
Blanco  
Para baño  
2 puertas  
(001824)

**ORGANIZADOR**  
Para baño  
Cromo  
(014932)

**BARRA DE CORTINA**  
Reforzada 6'  
(001088)

**DUCHA HIGIÉNICA**  
(Bidet)  
Blanca  
(058903)



**ESCOBA**  
Con mango metálico  
(011356)



**ESCOBILLÓN**  
con mango 34 cm  
(011370)



**PAPELERA**  
50 lt  
(055175)



**ZAFACÓN**  
45 gal  
Con tapa y ruedas  
(007388)



**ESCURRIDOR**  
De agua metálico  
75 cm  
(037452)



**SEÑAL PISO MOJADO**  
(055178)



**ZAFACÓN**  
Con pedal  
120 lt  
(055172)



**KÖNIN ASPIRADORA**  
Color blanco  
Recolector de cable automático  
Filtro de tela reutilizable  
Cepillo para alfombras graduable  
1200 w potencia  
Manguera de alta resistencia y flexibilidad  
Tubos plásticos extensibles  
(056622)



**ESCURRIDOR**  
De agua metálico  
45 cms  
(032183)



**DESARAÑADOR**  
Con palo extensible  
(011366)



**RECOGEDOR DE BASURA**  
Con goma Azul  
(037455)



**CUBETA EXPRIMIDORA**  
35 lt  
(055177)

**ZAFACÓN**  
Con pedal  
240 lt  
(055171)

Colores Disponibles:  
● ● ●

## ALMACENAMIENTO Y ORGANIZACIÓN



## ESCALERA TIJERA

**ESCALERA**  
2 peldaños  
(057988)



**ESCALERA TIJERA**  
FIBRA 4' (017457)  
FIBRA 6' (017458)



**ESCALERA TIJERA**  
Aluminio 3' (082012)  
Aluminio 5' (004804)







**FREGADERO DOBLE**  
Inoxidable  
33" x 19" x 7"  
(015074)

**FREGADERO DOBLE**  
Inoxidable  
33" x 22" x 7"  
(005204)



**FREGADERO DOBLE**  
32 1/4" x 18 1/8" x 8"  
Bajo Encimera (tope)  
(005190)



**TRITURADOR**  
De desperdicios  
Para fregadero  
(034719)

**FREGADERO DOBLE**  
Inoxidable  
33" x 22" x 6"  
(005211)



33" x 19" x 6"  
(005210)

**FREGADERO DOBLE INOXIDABLE**  
Extrareforzado / Profundo  
1 hoyo / 3 hoyos  
33" x 22"  
(039894)



**FREGADERO PARA BAR**  
Inoxidable  
(055945)



**FREGADERO SENCILLO INOXIDABLE**  
Con escurridor  
31" x 19"  
(093432)  
(093433)



**FREGADERO REDONDO**  
Inoxidable  
Diámetro 20" x 7"  
(019391)



**LLAVE**  
Para fregadero  
(027287)



**MEZCLADORA**  
Para fregadero de bar  
(006835)



**MEZCLADORA**  
Para fregadero  
(006966)



**MEZCLADORA**  
Para fregadero  
Cuello alto 8"  
(022010)





**MATERIALES INDUSTRIALES S.A.S.**

Av. San Martín No. 183, Santo Domingo, Rep. Dom.

Tel. (809) 227-6911 | [info@matisa.com.do](mailto:info@matisa.com.do)

[WWW.MATISA.COM.DO](http://WWW.MATISA.COM.DO)